

QUICK START GUIDE

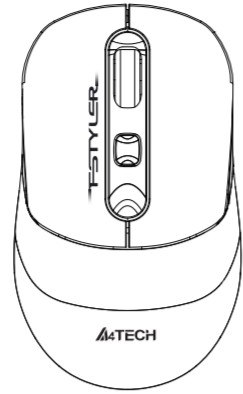

F810C/F810S

Bluetooth / 2.4G

FSTYLER COLLECTION

WHAT'S IN THE BOX



Mouse



Nano USB Receiver



Charging Cable (Type-C)



User Manual

KNOW YOUR PRODUCT

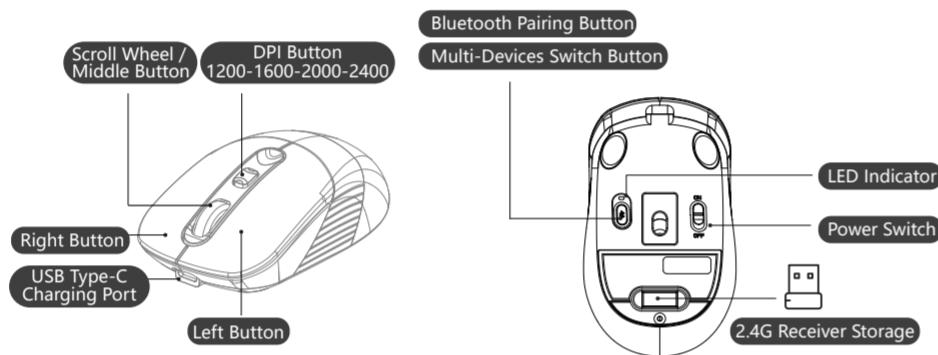

CONNECTING 2.4G DEVICE

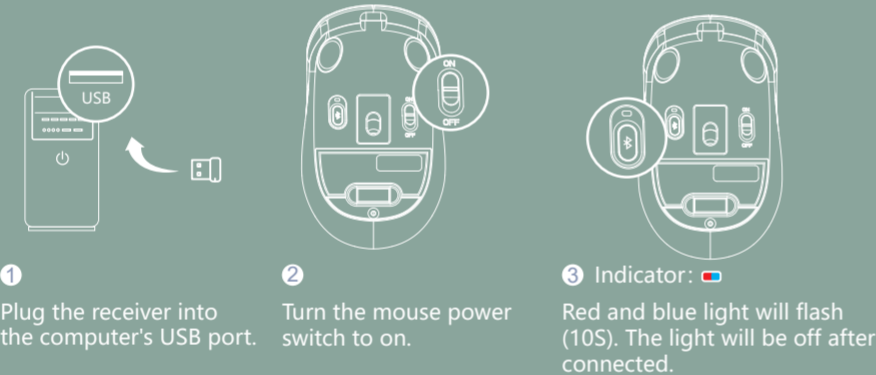

CONNECTING BLUETOOTH DEVICE 1 (For Mobile Phone/Tablet/Laptop)

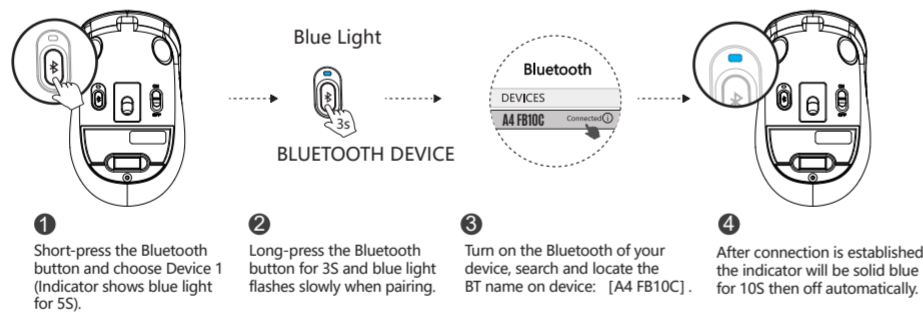

CONNECTING BLUETOOTH DEVICE 2 (For Mobile Phone/Tablet/Laptop)

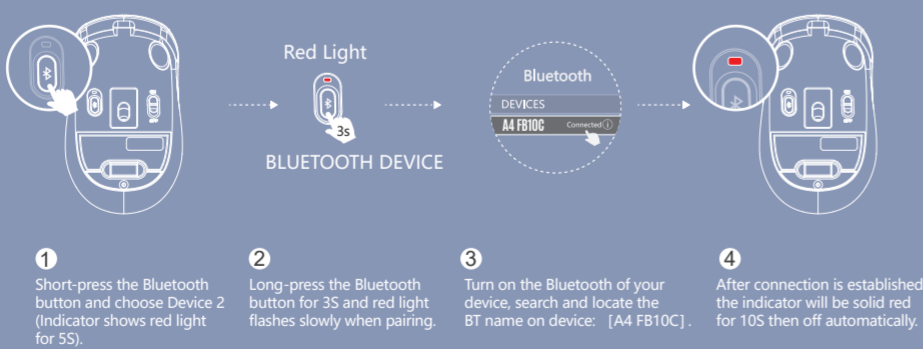

INDICATOR



MOUSE 2.4G DEVICE BLUETOOTH DEVICE 1 BLUETOOTH DEVICE 2

Indicator	Red and Blue Light	Blue Light	Red Light
Switch Device: Short-Press 1S	Flashes Quickly 10S	Solid Light 5S	Solid Light 5S
Pair Device: Long-Press For 3S	No Need to Pair	Pairing: Flashes Slowly Connected: Solid Light 10S	Pairing: Flashes Slowly Connected: Solid Light 10S

The above indicator status is before Bluetooth paired. After the Bluetooth connection succeed, the light will turn off after 10S.

CHARGING & INDICATOR

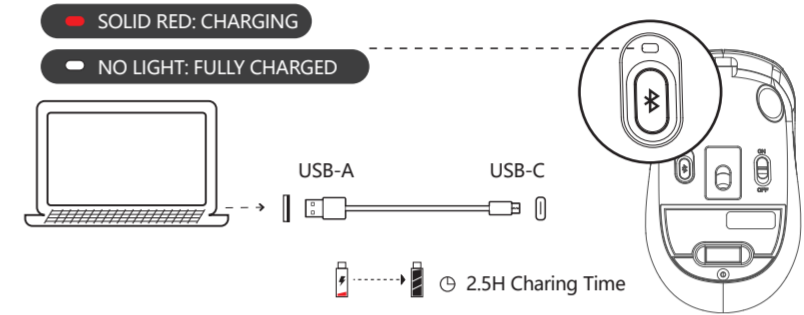

LOW BATTERY INDICATOR

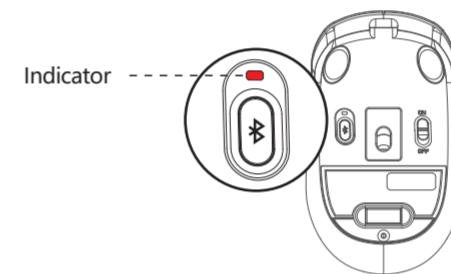

Flashing Red light indicates when the battery is below 25%.

Q & A

- Question** How many total devices can be connected at a time?
Answer Interchange and connect up to 3 devices at the same time. 2 Devices with Bluetooth + 1 Device with 2.4G Hz.
- Question** Does the mouse remember connected devices after power off?
Answer The mouse will automatically remember and connect last device. You may switch the devices as you choose to.
- Question** How do I know what device is currently connected to?
Answer When the power is turned on, the indicator light will be displayed for 10S.
- Question** How to switch connected Bluetooth devices?
Answer Repeat the procedure of connecting Bluetooth devices.

WARNING STATEMENT

- The following actions may/will cause damages to the product.
- To disassemble, bump, crush, or throwing into fire, you may cause irrefutable damages in event of the lithium battery leakage.
 - Do not expose under the strong sunlight.
 - Please obey all local laws when discarding the batteries, if possible please recycle it. Do not dispose it as household garbage, it may cause a fire or an explosion.
 - Please try to avoid charging in the environment below 0°C.
 - Do not remove or replace the battery.

EST. 1987
A4TECH®

FSTYLER
COLLECTION



www.a4tech.com



Scan for E-Manual